

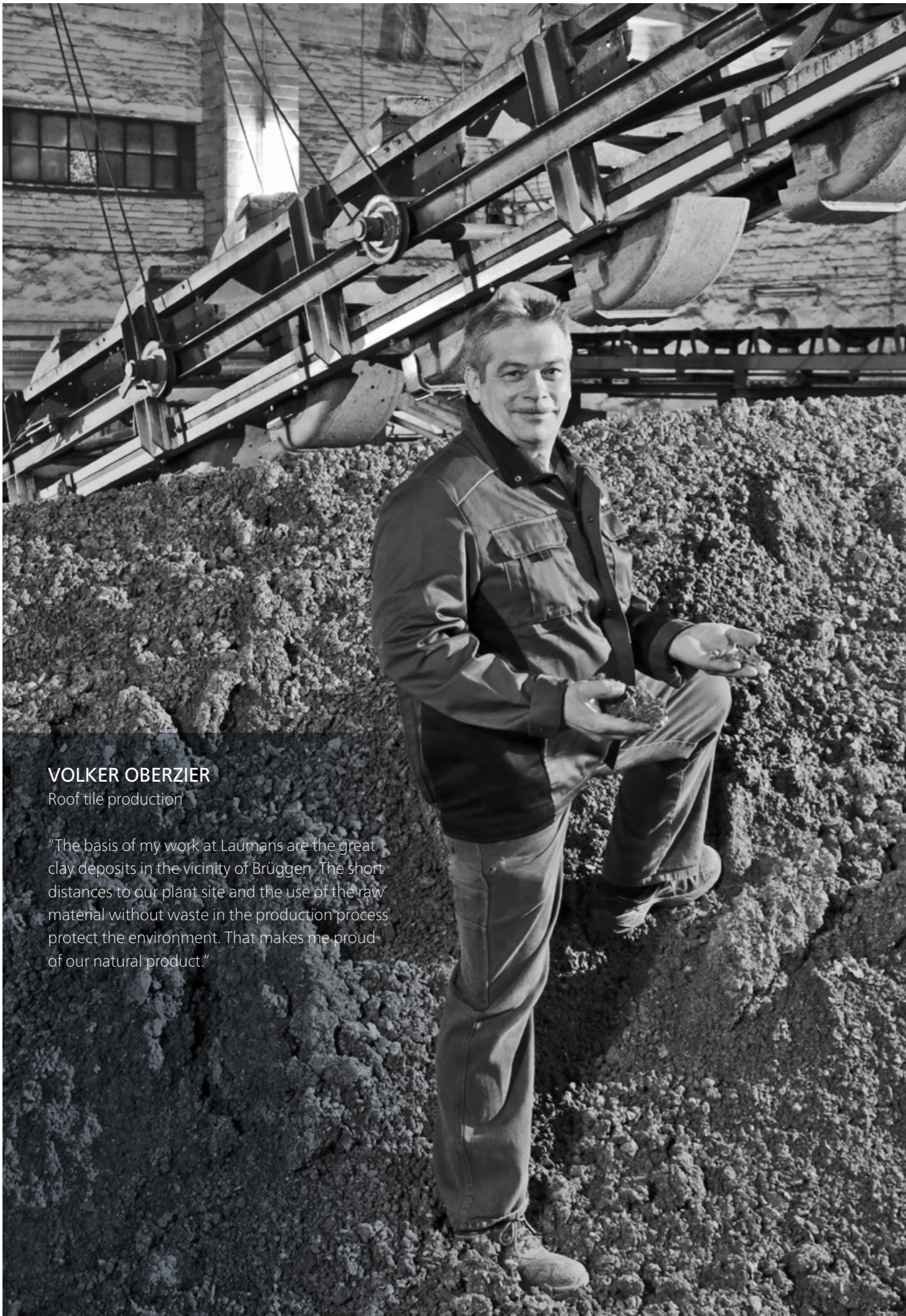

TIEFA XLTOP®

THE ECONOMICAL, FLEXIBLE
FLAT ROOF TILE



VOLKER OBERZIER
Roof tile production

"The basis of my work at Laumans are the great clay deposits in the vicinity of Brügggen. The short distances to our plant site and the use of the raw material without waste in the production process protect the environment. That makes me proud of our natural product."

THE FLEXIBLE FLAT ROOF TILE FOR ECONOMICAL ROOFS – TIEFA XLTOP®



The gentle curve of the **TIEFA XLTOP®** and the harmoniously calm surface effect are characteristic of this timeless modern flat roof tile. The flexible medium format of the popular **TIEFA XLTOP®** is also particularly economical and universally applicable - not just for the low-pitched roof.



TIEFA XLTOP®

THE ECONOMICAL, FLEXIBLE FLAT ROOF TILE

- 👁️ **Design:** straightforward, functional look with a flat, wide hollow
- 🏠 **Surface effect:** evenly calm and clearly structured
- 🔧 **Technology:** optimal rainfall safety in flat pitched roofs, variable covering length for quick and easy mounting
- 🏠 **Application:** suitable for roof renovation, modernization and new construction. Harmonizes particularly well with modern architecture

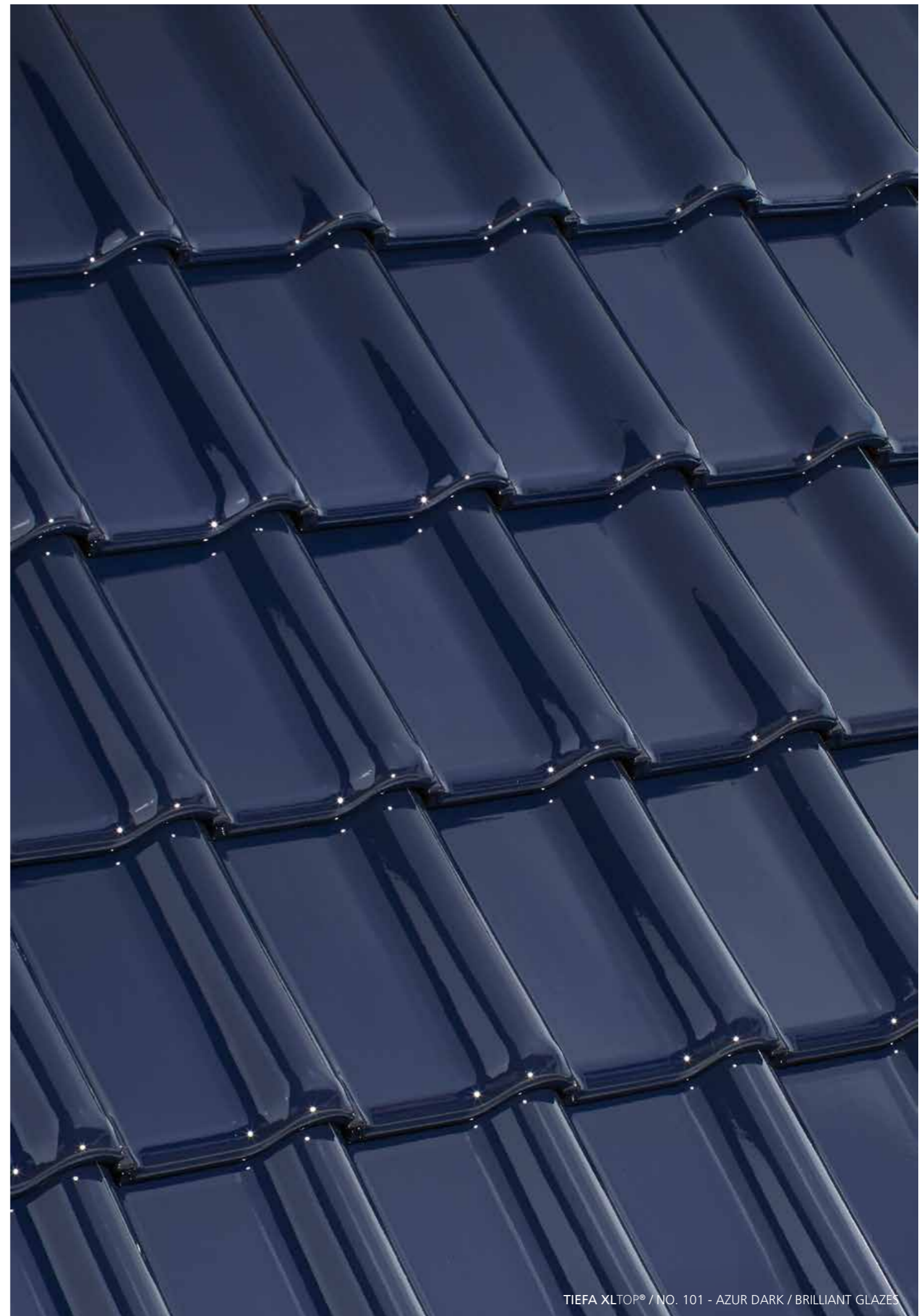

UNIQUE SURFACES AND EXCLUSIVE COLOURS FROM MATT TO HIGH GLOSS

FOR INDIVIDUAL AND CREATIVE ROOF DESIGN.

NATURAL ENGOBES – Matt surface

Clay suspension of natural minerals which is poured over the roof tile before firing.

SINTER-ENGOBES – Silky matt surface

Engobe refined by the addition of glass bodies

BRILLIANT GLAZES – Glossy surface

Ceramic coatings that fuse with the roof tile during firing.

TREND GLAZES – Extra matt-satined surface

Premium glazes with significantly reduced gloss.

30 YEARS WARRANTY ON ALL ROOF TILE PRODUCTS
First-class natural raw materials, groundbreaking production processes and comprehensive external and internal quality control ensure the consistently high quality of our roof tiles.



NO. 12 - ANTIQUE / NATURAL ENGOBES



NO. 14 - RED / NATURAL ENGOBES



NO. 18 - RUSTIQUE / NATURAL ENGOBES



NO. 30 - XENON-GREY / NATURAL ENGOBES



NO. 20 - BLACK / SINTER ENGOBES



NO. 21 - GREY / SINTER ENGOBES



NO. 22 - COPPER RED / SINTER ENGOBES







NO. 23 - BROWN / SINTER ENGOBES

40% MORE COLOUR –
100% MORE ENTHUSIASM



UNRIVALED LAUMANS COLOUR APPLICATION TECHNOLOGY.
OVERPOUR INSTEAD OF SPRAYING OR SPINNING

-  Up to 40 % higher thicknesses of coloured clay sludges for intense and consistent colours
-  Uniquely defined, lively colours for an exclusive and inimitable naturalness
-  Noticeably smoother roof tile surfaces for a perfect look and dirt-repellent effect
-  Extremely hard surfaces for protection against mechanical and environmental influences







ROOF TILES MADE OF CLAY: FROM NATURE - FOR NATURE



NO. 25 - GRAPHITE BLACK / SINTER ENGOBES



NO. 50 - BLACK / BRILLIANT GLAZES

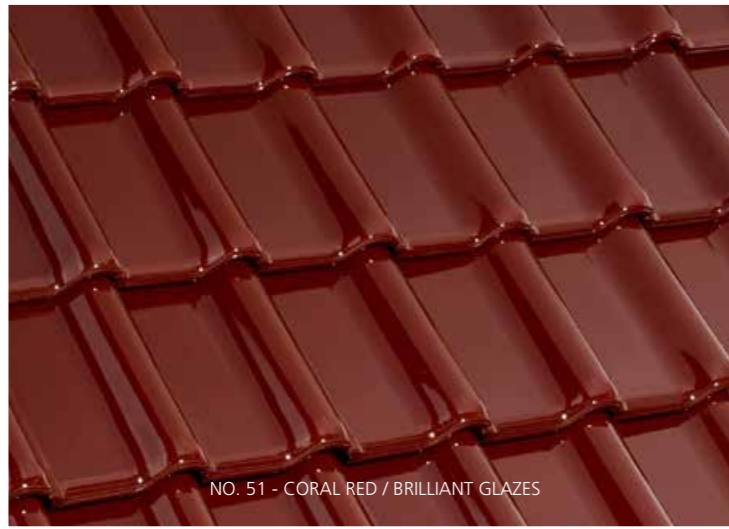

NO. 51 - CORAL RED / BRILLIANT GLAZES

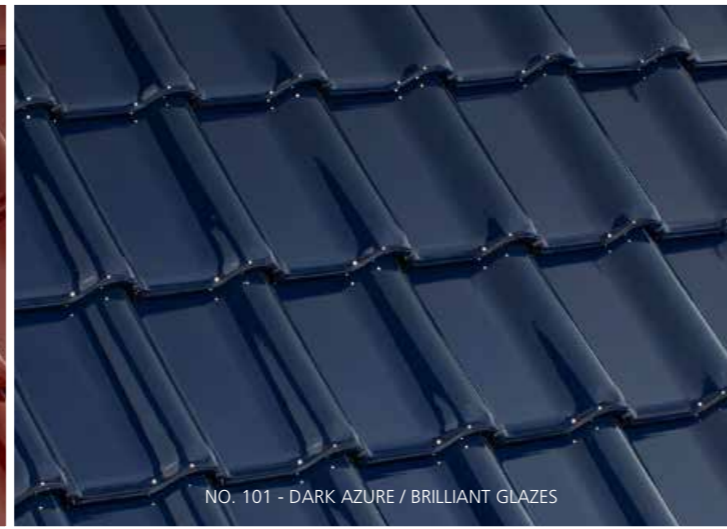

NO. 101 - DARK AZURE / BRILLIANT GLAZES

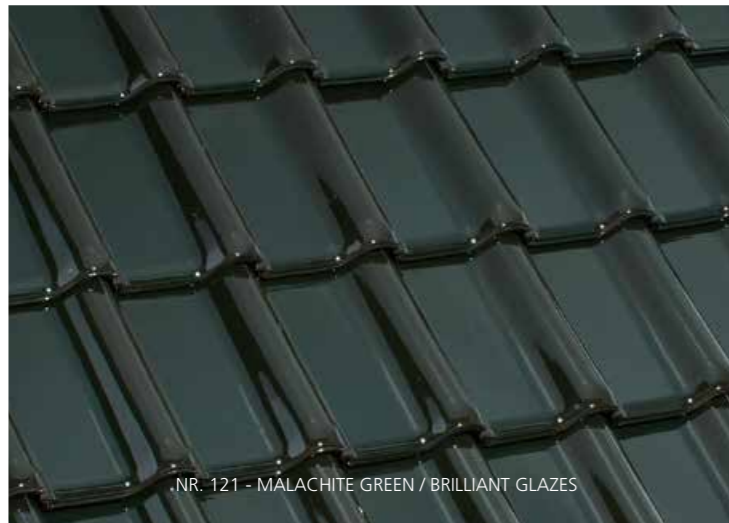

NR. 121 - MALACHITE GREEN / BRILLIANT GLAZES



NO.40 - SATIN BLACK / TREND GLAZES



NO.41 - SATIN GREY / TREND GLAZES

A SIGN OF QUALITY

Our innovative production method, which fires the tiles upside down to save space, increases energy efficiency and ensures that colour only reaches where it is needed. Uncoloured fold areas disappear after covering by overlapping of the surrounding tiles. This way you can save resources and make roofs sustainable.



Behind the desire to have a roof over your head there is always a need for security, warmth and peace. That's why builders and homeowners choose premium roof tiles made of Tegelen clay from the Lower Rhine region in Germany. Clay is a gift of nature and has many good qualities that improve our living standard and quality of life. One of the best points is that it can be moulded, dried and fired, thus providing us with roof tiles of outstanding quality.

HEALTHY ROOF

There is a saying that only in a healthy body can a healthy mind live. Something similar is the connection between a healthy roof and the well-being of the inhabitants. Because only if the roofing is made of natural building materials and has been produced environmentally friendly, will you feel at home with a permanently clear conscience.

PURE NATURE

Clay is a completely pure and natural building material and therefore completely recyclable. Only the four basic elements of earth, water, air and fire are effective in the formation of our roof tiles. They promote the exchange of air and moisture and defy the sun, storm, rain, ice and snow. From raw materials to manufacturing and use, Laumans roof tiles meet all the ecological and economic requirements for a future-oriented roofing material.

BECAUSE OF RESPONSIBILITY

For the responsible use of natural resources, Laumans has consistently relied on environmentally friendly manufacturing processes for more than 120 years. These include, among other things, the recultivation of quarrying sites, intelligent disposal and recycling solutions as well as energy, air and water-conserving production processes. The company's innovative production method, in which the tile models are fired free-standing and without touching one another, also ensures increased energy efficiency. This way roofs can be designed sustainably.

ADVANTAGE: NATURALITY

- Clay is an absolutely natural building material
- Only the four basic elements earth, water, air and fire are effective in the formation
- Clay increases the quality of living
- Roof tile products are 100% recyclable
- Resource-saving production processes
- Reclamation of clay pits
- Ecologically sensible and sustainable roofing material

ACCESSORIES MADE OF CLAY. FOR PERFECT ROOFS.

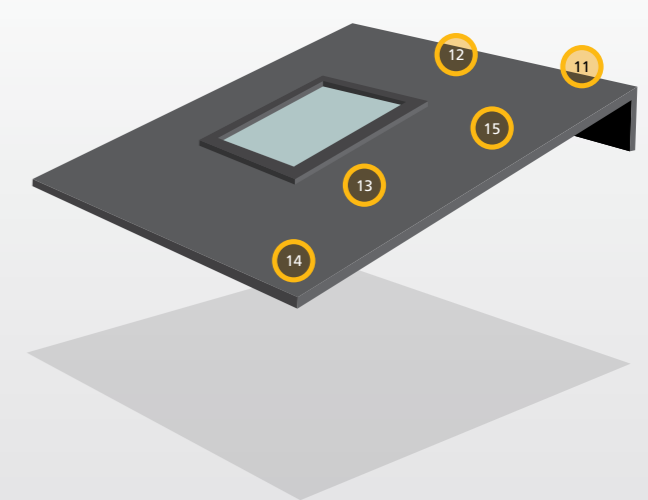
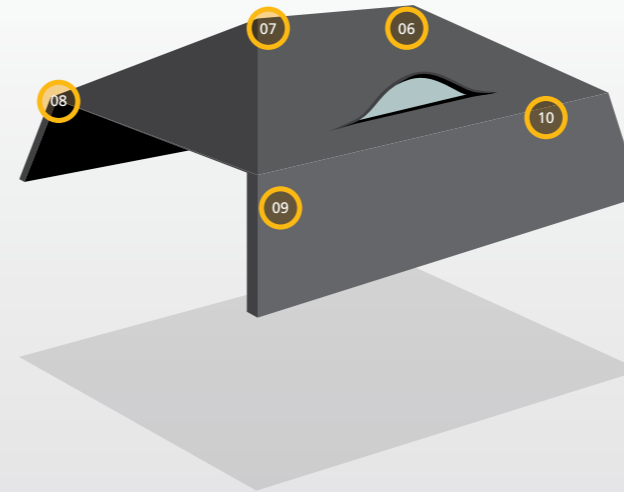
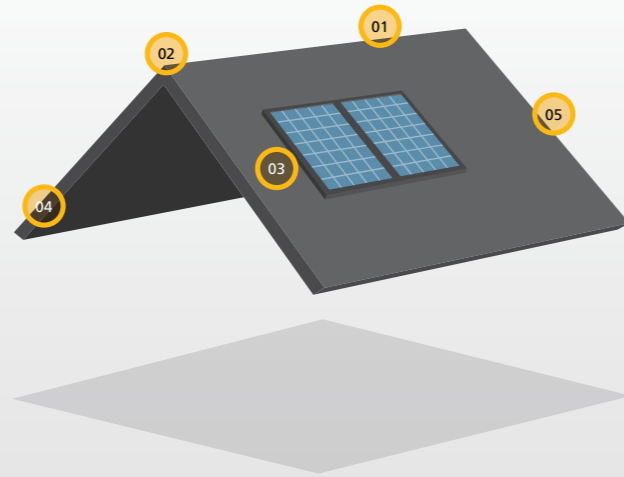

Only the all-ceramic roof, from the eaves to the ridge, guarantees the unmistakable overall performance of a Laumans clay tile roof. One in form and function unbeatable unit that defies all environmental influences and does not show material fatigue even after decades. Available in all available colours and finishes.

OTHER ACCESSORIES

We supply various roof accessories, such as snow chains, runners, and safety step pans for static or safety reasons, in a material combination of metal and / or plastic. These products are available upon request in the chosen roof tile colour.

ORNAMENTS MADE OF CLAY

Make your roof even more individual with ornaments made of clay. Whether rooster, sleepwalker or cat, your ideas have no limits. Talk to your specialist about the many possibilities.



01 RIDGE TILE
Perfect finishing tile for secure coverage of opposite roof surfaces on the ridge and hip.

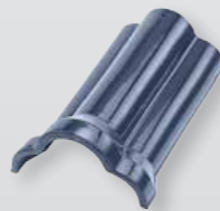

02 ROOF RIDGE ENDER
Elegant ridge formation as a starting or ending tile.

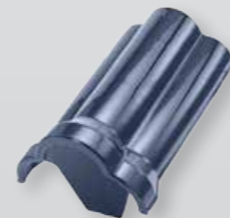

03 SOLAR CONNECTION
Indispensable accessory tile for solar systems for penetration of the connection cable and pipework

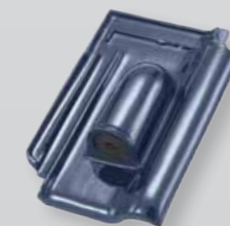

04 VERGE TILE INTERIOR BAULK
Visually compact finish to the side roof plane and protection for the roof connection against driving rain. Available for left and right sides.

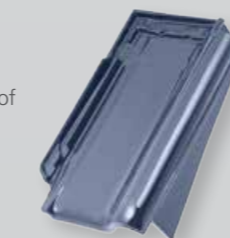

05 ANTENNA TILE
For the safe implementation of satellite dish and antenna masts.



06 FIRST DEPOSITORS
Technical and visual improvement of the reception of the ridge tile in the last tile row.



07 HIP CAP
All-ceramic covering of the transition between the ridge and hip. Suitable for roof pitches of 18–50°.



08 HIP STARTING TILE
Shapely and functional design for the start of the hip.



09 HALF TILE
Width compensation for existing roofs or for precise laying work on roof structures and roof windows.



10 MANSARD TILE
The accessory for creating mansard roofs or other creative roof shapes according to the requirements of the roofer.



11 SHED ROOF TILE
Finishing tile for all monopitch roofs. With 90° angle as a standard-shaped part. Other shapes at the roofer's request.

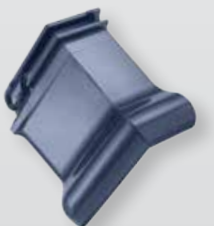

12 UNIVERSAL SHED ROOF TILE
Universal cover with finishing tiles.



13 DOUBLE BRIM TILE
Left-hand finish for ascending masonry or roof windows.



14 VENTILATION TILE
Additional surface ventilation in the eaves and ridge area. Ensures air circulation above the insulation and avoids condensation.

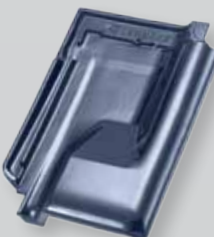

15 VENTILATION PIPE
For the driving rain-resistant ventilation of sanitary pipes and exhaust ducts over the roof.



TECHNOLOGY WITH SYSTEM

In addition to all visual aspects, the protective function and safety of your roof takes first place. Thanks to the wide contact surface and the pronounced suspension, the **TIEFA XLTOP®** is firmly and securely on the roof batten. The four-way covering and intensive locking in the four-tile corner gives the tile surface additional stability and makes it extremely safe against wind suction. The double interlocking joint defies driving rain and snow. **And this already for roof pitches from 12 ° with corresponding additional measures.**¹

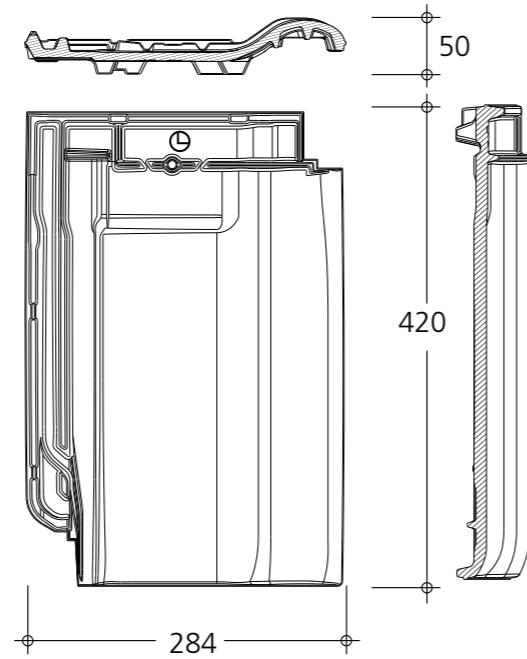

TIEFA XLTOP®

DIMENSIONS	COVERING LENGTH	COVERING WIDTH	REQUIRED	WEIGHT	MINIMUM ROOF PITCH	STANDARD ROOF PITCH	PACKAGE CONTENTS
approx. 420 x 284 mm	approx. 340 - 360 mm	approx. 230 mm	from approx. 12,2 per m ²	per pc.: approx. 3,7 kg per m ² : 44,8 - 47,4 kg	12° with under-roof	22°	240 pc. on europalett

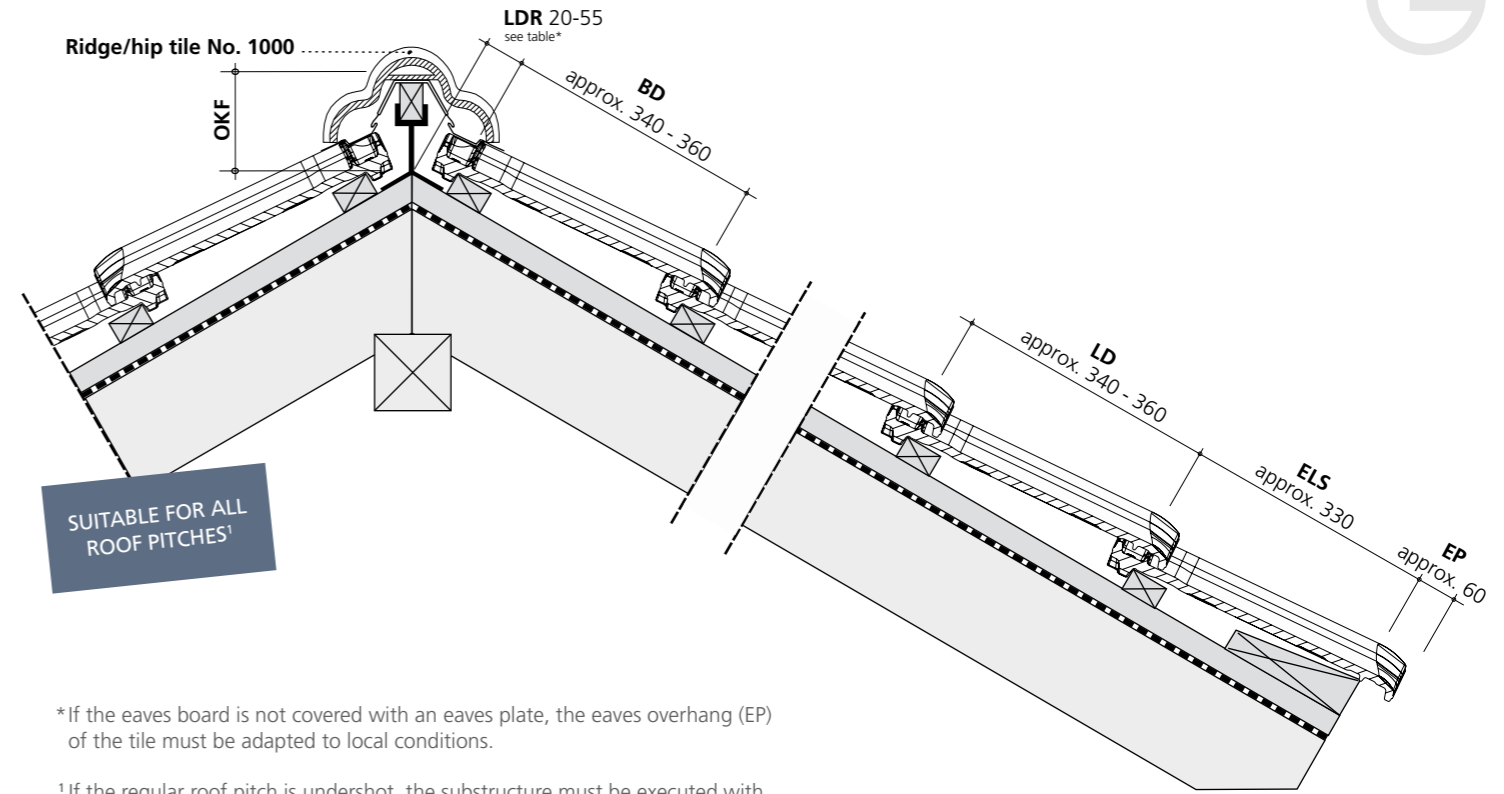

*If the eaves board is not covered with an eaves plate, the eaves overhang (EP) of the tile must be adapted to local conditions.

¹If the regular roof pitch is undershot, the substructure must be executed with increased requirements

EVALUATION/SIZING OF THE COVERING WIDTH

A: Verge tile with interior baulk

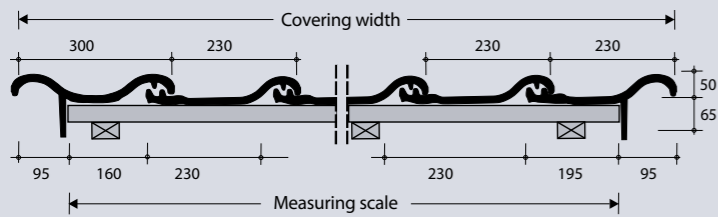

B: Double brim tile

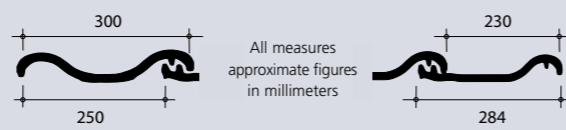

All measures approximate figures in millimeters

Tile clips for storm protection

- 409-221 Clipholster® to batten in ZIAL
- 456-205 Clipholster® to hang onto batten size 30 x 50 ZIAL
- 456-213 Clipholster® for batten size 40 x 60 ZIAL

Average covering width in rows without or with roof tile in mm construction width = respective measuring scale

REIHEN		01	02	03	04	05	06	07	08	09	10	11	12	13	14	15
Roof tile (RT)		230	460	690	920	1.150	1.380	1.610	1.840	2.070	2.300	2.530	2.760	2.990	3.220	3.450
Double brim tile + RT	250 284	-	-	764	994	1.224	1.454	1.684	1.914	2.144	2.374	2.604	2.834	3.064	3.294	3.524
Verge tile l./r. (interior baulk) + RT	160 195	-	-	585	815	1.045	1.275	1.505	1.735	1.965	2.195	2.425	2.655	2.885	3.115	3.345

REIHEN		16	17	18	19	20	21	22	23	24	25	26	27	28	29	30
Roof tile (RT)		3.680	3.910	4.140	4.370	4.600	4.830	5.060	5.290	5.520	5.750	5.980	6.210	6.440	6.670	6.900
Double brim tile + RT		3.754	3.984	4.214	4.444	4.674	4.904	5.134	5.364	5.594	5.824	6.054	6.284	6.514	6.744	6.974
Verge tile l./r. (interior baulk) + RT		3.575	3.805	4.035	4.265	4.495	4.725	4.955	5.185	5.415	5.645	5.875	6.105	6.335	6.565	6.795

EVALUATION/SIZING OF THE RAFTER LENGTH

Eaves overhang (EP) 60 mm: number of rows (according to chart) + lath distance eaves (ELS) + lath distance ridge (LDR)

Covering length

ROWS	01	02	03	04	05	06	07	08	09	10
COVERING LENGTH in mm	340	680	1.020	1.360	1.700	2.040	2.380	2.720	3.060	3.400
	350	700	1.050	1.400	1.750	2.100	2.450	2.800	3.150	3.500
	360	720	1.080	1.440	1.800	2.160	2.520	2.880	3.240	3.600
ROWS	11	12	13	14	15	16	17	18	19	20
COVERING LENGTH in mm	3.740	4.080	4.420	4.760	5.100	5.440	5.780	6.120	6.460	6.800
	3.850	4.200	4.550	4.900	5.250	5.600	5.950	6.300	6.650	7.000
	3.960	4.320	4.680	5.040	5.400	5.760	6.120	6.480	6.840	7.200
ROWS	21	22	23	24	25	26	27	28	29	30
COVERING LENGTH in mm	7.140	7.480	7.820	8.160	8.500	8.840	9.180	9.520	9.860	10.200
	7.350	7.700	8.050	8.400	8.750	9.100	9.450	9.800	10.150	10.500
	7.560	7.920	8.280	8.640	9.000	9.360	9.720	10.080	10.440	10.800

All values are determined with a 30 x 50 mm lathing. If other slat cross sections are used, than these must be checked at the construction site beforehand!

The accurate lath spacing has to be determined at the building site with the delivered tiles.

Lath distance ridge (LDR)

Using roof tiles				
Roof pitch	20°	30°	40°	50°
Ridge No. 1000	55 mm	50 mm	40 mm	29 mm
Ridge No. 300	55 mm	45 mm	35 mm	20 mm

Further fitting tiles available

Term	Covering width/Measuring scale
Half tile	115 mm
Ventilation tile, ventilation approx. 18 cm ²	230 mm
Vent pipe/antenna opening tile	230 mm
Solar connection tile, admission max. 65 mm Ø	230 mm
Shed roof tile 90°, side length 220/100 mm	230 mm
Shed roof verge tile left	300 mm / 160 mm
Shed roof verge tile right	230 mm / 195 mm
Ridge inlay	

Shed roof tiles with different slopes and dimensions, mansard tiles etc. on request.

For ridge / hip tile and accessories, see pages 16–19

Distance from ridge vertex / Top of ridge lath (OKF):

Using roof tiles				
Roof pitch	20°	30°	40°	50°
Ridge No. 1000	150 mm	130 mm	120 mm	105 mm
Ridge No. 300	140 mm	130 mm	120 mm	105 mm



Gebr. Laumans GmbH & Co. KG
Stiegstr. 88, D-41379 Brüggen
Phone: +49 21 57 14 13 0
Fax: +49 21 57 14 13 39
info@laumans.de, www.laumans.de

